

# **BTS Series Usual Manual**

## **Intelligent Batteries System**

Product Model: BTS E5~E20-DS5

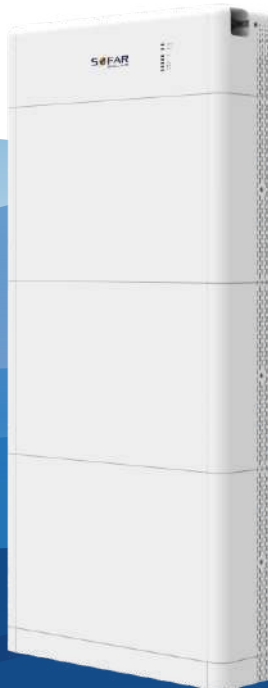

---

---

## Contents

|  |     |
|--|-----|
| Preface .....  | III |
| <b>1. Basic Safety Information</b> .....                 | 1   |
| 1. 1. Requirement for Installation and Maintenance ..... | 1   |
| 1. 2. Description of safety information symbols .....    | 4   |
| <b>2. Product Introduction</b> .....                     | 6   |
| 2. 1. Product overview .....                             | 6   |
| 2. 2. Product Model Description .....                    | 7   |
| 2. 3. Product Appearance .....                           | 9   |
| 2. 4. Indicator lights description .....                 | 10  |
| 2. 5. Product label .....                                | 14  |
| 2. 6. System capacity expansion description .....        | 15  |
| <b>3. Product Installation</b> .....                     | 16  |
| 3. 1. Checking Before Installation .....                 | 16  |
| 3. 2. Preparation for Installation Tools .....           | 19  |
| 3. 3. Installation environment .....                     | 21  |
| 3. 4. Installation Space .....                           | 22  |
| 3. 5. Battery system installation .....                  | 22  |
| <b>4. Electrical Connection</b> .....                    | 27  |
| 4. 1. Preparation of Connection Cables .....             | 28  |
| 4. 2. Electrical Connection for Internal System .....    | 28  |
| 4. 3. External Electrical Connection .....               | 33  |
| 4.3.1 External Electrical Connection .....               | 33  |
| 4. 4. Battery parallel installation .....                | 40  |
| 4. 5. Fuse replacement .....                             | 40  |
| 4. 6. Install the protective cover .....                 | 41  |
| <b>5. Commissioning</b> .....                            | 43  |
| 5. 1. Double Check .....                                 | 43  |
| 5. 2. Electrify for the First Time (Important) .....     | 43  |
| 5. 3. Battery Parameter Settings .....                   | 43  |
| 5. 4. Software Update .....                              | 45  |

|  |           |
|--|-----------|
| 5. 5. Battery Powered Off.....                                     | 46        |
| <b>6. <i>Trouble shooting and maintenance</i> .....</b>            | <b>47</b> |
| 6. 1. Troubleshooting .....  | 47        |
| 6. 2. Daily Maintenance .....                                      | 49        |
| 6. 3. Battery Module Storage Requirements and Power Supply .....   | 50        |
| <b>7. <i>Technical Parameters</i> .....</b>                        | <b>52</b> |
| <b>8. <i>Manufacturer's Warranty and Liability Terms</i> .....</b> | <b>54</b> |

# Preface

## Notice

The purchased products, services and features are governed by the commercial contract made by the Company. All or part of the products and features described in this document may not be within the purchase scope. Except as otherwise agreed herein, no representations or warranties, express or implied, are made as to the contents of this document.

## Save this Instruction

This manual must be considered as an integral part of the equipment. Customer can print the electronic version to hard copy and keeping properly for future reference. Anyone who operates the device at any time must operate in accordance with the requirements of this manual.

## Copyright Declaration

The copyright of this manual belongs to Shenzhen SOFARSOLAR Co., Ltd. Any corporation or individual should not plagiarize, partially cope or fully copy (including software, etc.), not allow to duplication and publishment in any form and any way. All rights reserved, SOFARSOLAR reserves the right of final interpretation. This manual subject to modify according to user's or customer's feedback. Please check our website at <http://www.sofarsolar.com> for lasted version.

## Document Updates

V1.0 2022-5-24

- Initial version

V1.1 2022-6-13

- Update Product Label
- Update 7.Technical Parameters

## Outline

It describes the assembly, installation, commissioning ,maintenance and failure of the product. Please read it carefully before operating.

## Scope of Validity

This product user manual describes the installation, electrical connection, debugging, maintenance and troubleshooting of BTS series intelligent battery system. The series includes the following models:





BTS E5-DS5      BTS E10-DS5      BTS E15-DS5      BTS E20-DS5

## Target Group

This document is intended for professional electrical engineers who are responsible for battery installation and commissioning, including technical support engineers, system engineers, and electrical engineers

## Symbols Used

In order to ensure the personal and property safety of users when using BTS series intelligent battery system, as well as the efficient use of this product, the manual provides relevant safe operation information and highlights it with corresponding symbols. These stressed messages must be fully understood and absolutely adhered to avoid personal injury and property damage. The symbols used in this manual are listed below.

|   |   |
|---|---|
| <br><b>Danger</b>  | <p>“Danger”indicates a hazardous situation which, if not avoided, will result in death or serious injury.</p>       |
| <br><b>Warning</b> | <p>“Warning”indicates a hazardous situation which, if not avoided, could result in death or serious injury</p>      |
| <br><b>Caution</b> | <p>“Caution”indicates a hazardous situation which, if not avoided, could result in minor or moderate injury</p>     |
|                    | <p>“Attention”indicates there are potential risks, if fail to prevent, may lead to equipment cannot normally or</p> |

|   |   |
|---|---|
| <b>Attention</b>  | property damage.  |
|  | “Note” provides additional information and tips that are valuable for the optimal operation of the product, will help you to solve a problem or save your time. |
| <b>Note</b>   |   |

# 1. Basic Safety Information

Please read the instruction carefully. Faulty operation may cause serious injury or death .



Note

If you have any question or problem when you read the following information, please contact Shenzhen SOFARSOLAR CO., Ltd.

## 1. 1. Requirement for Installation and Maintenance

The installation of BTS series intelligent battery system must be in full compliance with national and local laws and regulations.

Read and understand all instructions contained in this manual and familiarize yourself with safety symbols before installing and commissioning the device.

For any maintenance or repair, please contact the nearest authorized repair center. For information about the nearest authorization center, contact your reseller. Do not repair by yourself, which may cause personal injury or property injury.

Before installing and maintaining the device, disconnect the device from the external device using the DC switch. Otherwise, the high voltage may cause serious injury.

SOFARSOLAR will not be responsible for any personal injury or property injury caused by improper use.

### Installation and maintenance personnel requirements

The personnel responsible for installation and maintenance of the equipment for the first voyage must first receive strict training, understand various safety precautions and master correct operation methods.

- Only qualified professionals or trained personnel are allowed to install, operate, and maintain the device.
- Only qualified professionals are allowed to remove safety facilities and repair devices.
- The personnel, including the operators, trained personnel, and professional personnel, who operate the equipment should have the special operation qualification required by the local state, such as the qualification of high voltage operation, height climbing, and special equipment operation.
- Only professional or authorized personnel can replace equipment or components (including software).

**Note:**

- Professional personnel: those who have the training or operation experience of equipment and are able to understand the potential sources and magnitude of hazards in the process of equipment installation, operation and maintenance.
- Trained personnel: personnel who have received the appropriate technical training and have the necessary experience are aware of the risks that may be posed to them in performing a certain operation and can take measures to minimize the risks to themselves or other personnel.
- Operators: operators who may have access to the equipment except trained and professional personnel.

### **Assembly Condition**

Assemble the BTS intelligent battery system as detailed in the following sections of this manual. Place the battery in a position that can be fixed

on the edge and ensure that it is placed vertically. A suitable place for installation of electrical equipment should be selected to ensure sufficient space for fire escape for maintenance in case of failure. Maintain proper ventilation to ensure adequate air circulation for cooling, and air humidity is recommended to be less than <90% during assembly.

### **Transportation Requirement**

The Batteries are in the good electrical and physical condition when it ship out from factory. During transport, battery module must be placed in its original package or other proper package. Transportation company should responsible for any damage during transport period. Please check the battery thoroughly when taking delivery. If you find any packing problems that may cause the damage of inverter or any visible damage, please notice the responsible transportation company immediately. You can ask your installer or SOFARSOLAR for help is necessary.





This product contains battery module through UN38.3, belongs to the ninth category of dangerous goods. Therefore, loading and unloading must comply with local laws and regulations and industry standards during transportation. Rough loading and unloading may cause short circuit or damage to batteries in containers, which may result in battery leakage, breakage, explosion, or fire.

#### **Requirement During the Transportation**

- Shipping complies with the IMDG CODE and the International Maritime Dangerous Goods CODE.
- For land transportation, comply with ADR or JT T617 shipping requirements
- Meet the regulatory requirements of the transport regulatory authorities of the country of origin, route and destination.
- Comply with international regulations for the transport of dangerous goods and the supervision requirements of the



corresponding national transport regulatory authorities.



## 1. 2. Description of safety information symbols

|   |   |
|---|---|
|  | High voltage of battery may be harmful to health!<br>Only certified engineer can operate the product;<br>Juveniles, Disable, should not use this product;   |
| <b>Danger</b>   | Keep this product out of the reach of children;   |
|  | Caution of burn injuries due to hot enclosure!<br>Only touch the screen and pressing key of the product while it is working   |
| <b>Caution</b>  |   |
|  | Batteries should be grounded in accordance to the requirements of the local electrical grid company   |
| <b>Attention</b>  |   |
|  | To ensure that the battery is used in the equipment system authorized by SOFARSOLAR, and the battery is damaged or other losses caused by illegal use or unauthorized use of the equipment by SOFARSOLAR. SOFARSOLAR has the right not to do warranty, not to bear joint liability. |
| <b>Warning</b>  |   |

### Sings on the battery module





The battery module carries a number of safety related labels. Make sure to read and understand the labels carefully before installing the device.

| Symbols   | Name  | Explanation   |
|---|---|---|
|  | This is a residual voltage in the battery module! | There is a high voltage,when the battery is powered on. After the battery is powered off, the internal capacitor is still charged, operator should wait for 5 minutes to ensure the capacitor is completely discharged. |
|  | Caution of high voltage and electric shock        | The battery module operates at high voltages. Prior to performing any work on the product, disconnect the   |

|   |                           |  |
|---|---------------------------|--|
|   |                           | product from voltage sources. All work on the product must be carried out by qualified persons only. |
|  | Caution of hot surface    | The battery module can get hot during operation. Avoid contact during operation.                     |
|  | Grounding Terminal        | Connect the battery module to the ground bar for grounding protection                                |
|  | Observe the documentation | Read all documentation supplied with the product before install                                      |

### Sings on the battery distribution unit

The battery distribution unit carries a number of safety related labels. Make sure to read and understand the labels carefully before installing the device.

| Symbols   | Name  | Explanation   |
|---|---|---|
|    | This is a residual voltage in the battery module! | There is a high voltage,when the battery is powered on. After the battery is powered off, the internal capacitor is still charged, operator should wait for 5 minutes to ensure the capacitor is completely discharged. |
|  | Caution of high voltage and electric shock        | The battery module operates at high voltages. Prior to performing any work on the product, disconnect the product from voltage sources. All work on the product must be carried out by qualified persons only.          |
|  | Caution of hot surface                            | The battery module can get hot during operation. Avoid contact during operation.  |
|  | Grounding Terminal                                | Connect the battery module to the ground bar for grounding protection   |
|  | Observe the documentation                         | Read all documentation supplied with the product before install   |

## ***2. Product Introduction***

### **2. 1. Product overview**

BTS series intelligent battery system is mainly composed of battery module and battery distribution unit. The input and output voltages are high DC voltage. The system adopts modular design and stacked installation method. The capacity can be flexibly configured based on actual requirements. The capacity ranges is 5kWh ~ 40kWh.

#### **The main features are as follows:**

- Full modular design, easy to install and transport;
- Current balance between battery modules, higher battery available capacity;
- Capacity Expansion by Stages;
- Low power consumption of battery;
- One key activate/shutdown.

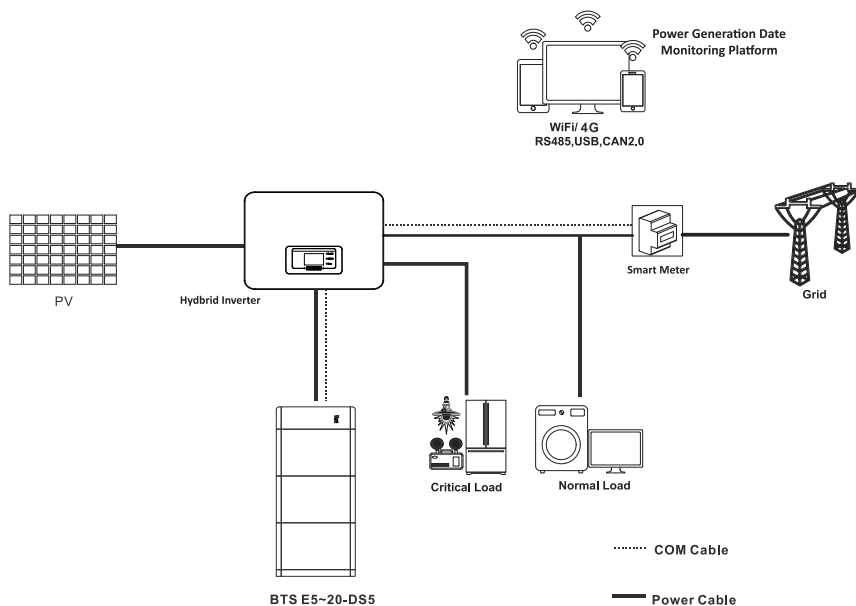

Figure.2-1 BTS series application principle diagram

## 2. 2. Product Model Description

**Battery module:**

BTS 5K

①

②

| Identifiers | Meaning                     | Specification                             |
|-------------|-----------------------------|---|
| ①           | Product series name         | SOFARSOLAR BTS series battery module name |
| ②           | Battery module energy grade | 5K: Battery module energy is 5kWh         |

**Battery distribution unit:**

**BTS 5K–BDU**

①

②

③

| Identifiers | Meaning                     | Specification                             |
|-------------|-----------------------------|---|
| ①           | Product series name         | SOFARSOLAR BTS series battery module name |
| ②           | Battery module energy grade | 5K: Battery module energy is 5kWh         |
| ③           | System Unit                 | BDU: Battery distribution unit            |

**Battery system:**

**BTS E5–DS5**

①

②

③

| Identifiers | Meaning             | Specification  |
|-------------|---------------------|--|
| ①           | Product series name | SOFARSOLAR BTS series battery module name  |
| ②           | Energy grade        | E5: Battery total energy is 5kWh<br>E10: Battery total energy is 10kWh<br>E15: Battery total energy is 15kWh<br>E20: Battery total energy is 20kWh |
| ③           | Battery module mode | DS5: Battery module is BTS 5K  |

## 2. 3. Product Appearance

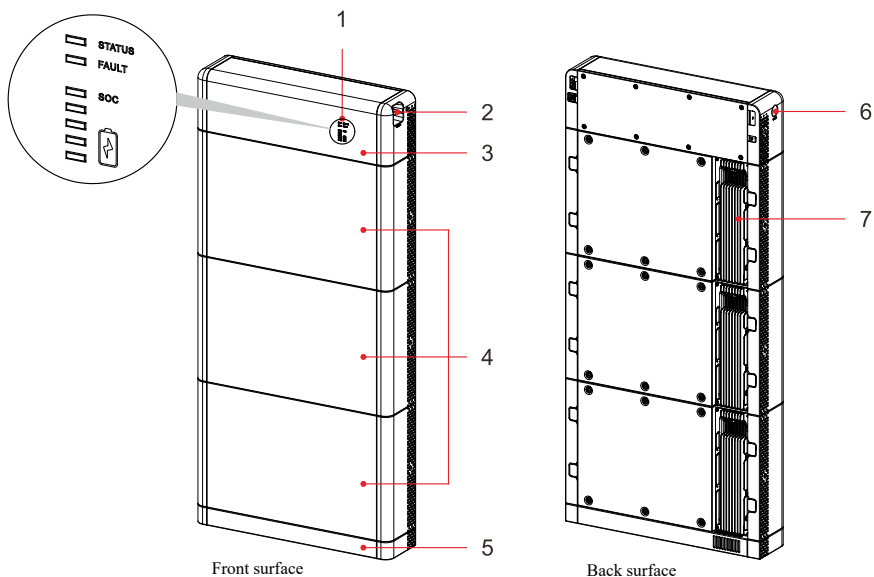

Figure .2-2 System appearance

- |                   |             |                             |
|-------------------|-------------|-----------------------------|
| 1 Indicator light | 2 DC switch | 3 Battery distribution unit |
| 4 Battery module  | 5 Base      | 6 Black startup switch      |
|                   |             | 7 Heat sink                 |

### Battery distribution unit:

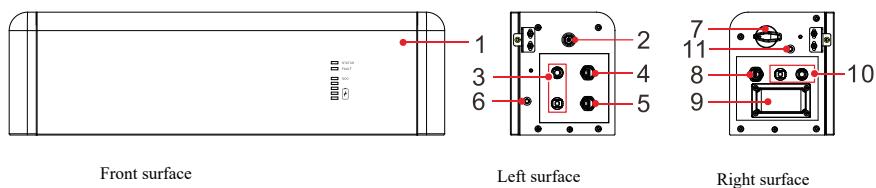

Figure.2-3 Schematic diagram of battery power distribution unit ports

- |  |                                    |                                      |
|--|------------------------------------|--------------------------------------|
| 1 Battery distribution unit              | 2 Black startup switch             | 3 Battery input (BAT IN)             |
| 4 BDU cascading communication port(Link) | 5 BDU communication input (COM-IN) |                                      |
| 6 Grounding hole                         | 7 DC switch                        | 8 BDU communication output (COM-OUT) |
| 9 Fuse                                   | 10 Battery output (BAT Out)        | 11 Grounding hole                    |

## Battery module port:

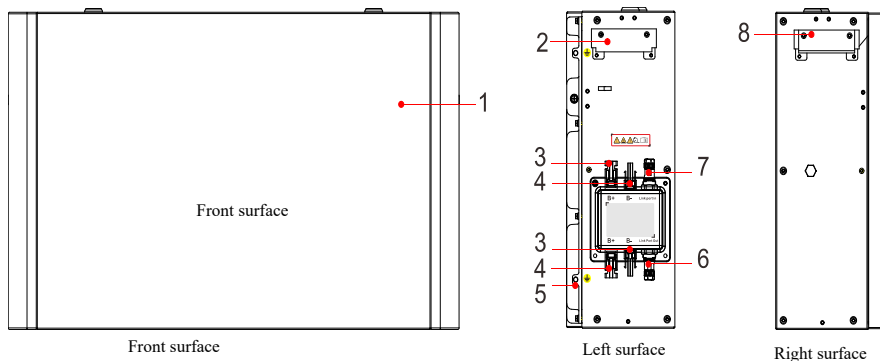

Figure.2-4 Battery module port diagram

- |                                      |                     |  |
|--------------------------------------|---------------------|--|
| 1 Battery module                     | 2 Left side handle  | 3 Output terminal B+                   |
| 4 Output terminal B-                 | 5 Grounding hole    | 6 Communication output (Link Port Out) |
| 7 Communication input (Link Port In) | 8 Right side handle |  |

## 2. 4. Indicator lights description

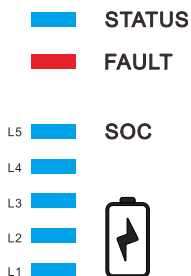

Figure.2-5 Indicator diagram

### Normal status indicator light:

Table 2-1. Normal status indicator light definition

|          | Status light | Alarm light | SOC light |     |     |     |     |
|----------|--------------|-------------|-----------|-----|-----|-----|-----|
|          |              |             | L1        | L2  | L3  | L4  | L5  |
| Shutdown | Off          | Off         | Off       | Off | Off | Off | Off |

|           |                      |     |  |
|-----------|----------------------|-----|--|
| Standby   | Green light flashing | Off | Display according to the battery SOC value |
| Updating  | Blue light flashing  | Off |  |
| Charge    | Blue light ON        | Off |  |
| Discharge | Green light ON       | Off |  |

### SOC Indicator light definition:

Table 2-2. SOC indicator light definition while charging

| SOC value | SOC light |          |          |          |          |
|-----------|-----------|----------|----------|----------|----------|
|           | L1        | L2       | L3       | L4       | L5       |
| 0%~5%     | Off       | Off      | Off      | Off      | Off      |
| 6%~25%    | Flashing  | Off      | Off      | Off      | Off      |
| 26%~50%   | ON        | Flashing | Off      | Off      | Off      |
| 52%~75%   | ON        | ON       | Flashing | Off      | Off      |
| 76%~95%   | ON        | ON       | ON       | Flashing | Off      |
| 96%~100%  | ON        | ON       | ON       | ON       | Flashing |

Table 2-3. SOC indicator light definition while discharging

| SOC Value | SOC light |     |     |     |     |
|-----------|-----------|-----|-----|-----|-----|
|           | L1        | L2  | L3  | L4  | L5  |
| 0%~5%     | Off       | Off | Off | Off | Off |
| 6%~25%    | ON        | Off | Off | Off | Off |
| 26%~50%   | ON        | ON  | Off | Off | Off |
| 52%~75%   | ON        | ON  | ON  | Off | Off |
| 76%~95%   | ON        | ON  | ON  | ON  | Off |

|          |    |    |    |    |    |
|----------|----|----|----|----|----|
| 96%~100% | ON | ON | ON | ON | ON |
|----------|----|----|----|----|----|

**Alarm status indicator:**

| Alarm status                                   | Status light | Alarm light | SOC light |     |     |     |     |
|--|--------------|-------------|-----------|-----|-----|-----|-----|
|  |              |             | L1        | L2  | L3  | L4  | L5  |
| High temperature alarm                         | Off          | Flashing    | ON        | Off | Off | Off | Off |
| Low temperature alarm                          | Off          | Flashing    | Off       | ON  | Off | Off | Off |
| Over voltage alarm                             | Off          | Flashing    | Off       | Off | ON  | Off | Off |
| Under voltage alarm                            | Off          | Flashing    | Off       | Off | Off | ON  | Off |
| Over current alarm                             | Off          | Flashing    | Off       | Off | Off | Off | ON  |
| Battery cell temperature differential abnormal | Off          | Flashing    | ON        | ON  | Off | Off | Off |
| Monomer differential pressure is too large     | Off          | Flashing    | Off       | ON  | ON  | Off | Off |
| Abnormal ambient temperature                   | Off          | Flashing    | Off       | Off | ON  | ON  | Off |

|       |     |          |    |    |    |    |    |
|-------|-----|----------|----|----|----|----|----|
| Other | Off | Flashing | ON | ON | ON | ON | ON |
|-------|-----|----------|----|----|----|----|----|

**Fault status indicator light:**

| Alarm status                                     | Status light | Alarm light | SOC light |     |     |     |     |
|--|--------------|-------------|-----------|-----|-----|-----|-----|
|  |              |             | L1        | L2  | L3  | L4  | L5  |
| High temperature fault                           | Off          | ON          | ON        | Off | Off | Off | Off |
| Low temperature fault                            | Off          | ON          | Off       | ON  | Off | Off | Off |
| Battery over voltage                             | Off          | ON          | Off       | Off | ON  | Off | Off |
| Battery low voltage                              | Off          | ON          | Off       | Off | Off | ON  | Off |
| Battery over current                             | Off          | ON          | Off       | Off | Off | Off | ON  |
| Battery cell temperature differential protection | Off          | ON          | ON        | ON  | Off | Off | Off |
| Monomer differential pressure protection         | Off          | ON          | Off       | ON  | ON  | Off | Off |
| Ambient temperature protection                   | Off          | ON          | Off       | Off | ON  | ON  | Off |
| Communication fault                              | Off          | ON          | ON        | Off | ON  | Off | Off |
| Sampling fault                                   | Off          | ON          | ON        | Off | Off | ON  | Off |
| Battery cell fault                               | Off          | ON          | Off       | ON  | Off | Off | Off |
| BMS internal fault                               | Off          | ON          | Off       | ON  | ON  | ON  | Off |

|                                  |     |    |    |     |     |     |     |
|----------------------------------|-----|----|----|-----|-----|-----|-----|
| PCU internal fault               | Off | ON | ON | ON  | ON  | Off | Off |
| Fuse damaged                     | Off | ON | ON | Off | ON  | ON  | Off |
| Terminal connection abnormal.    | Off | ON | ON | ON  | Off | ON  | Off |
| Software version is inconsistent | Off | ON | ON | ON  | ON  | ON  | Off |
| Other                            | Off | ON | ON | ON  | ON  | ON  | ON  |

## 2. 5. Product label

### Battery distribution unit:

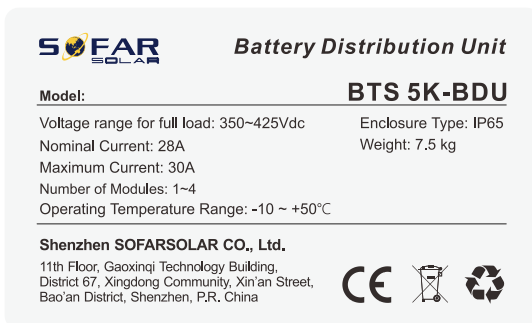

Figure.2-6 Battery distribution unit label

### Battery module:

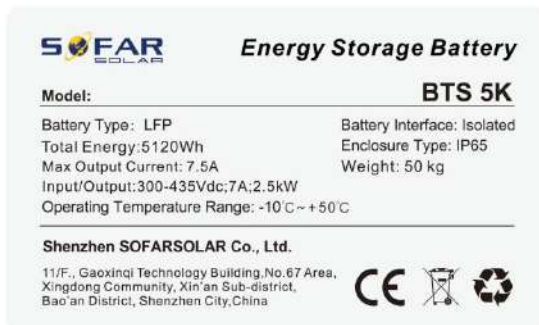

Figure.2-7 Battery module label

## 2. 6. System capacity expansion description

The BTS series intelligent battery system supports capacity expansion. Up to four battery modules are managed by one BDU and supports up to two BDU in a communication network. Each BDU has independent output. The expandable capacity of the single-cluster battery system ranges is 5kWh ~ 20kWh.

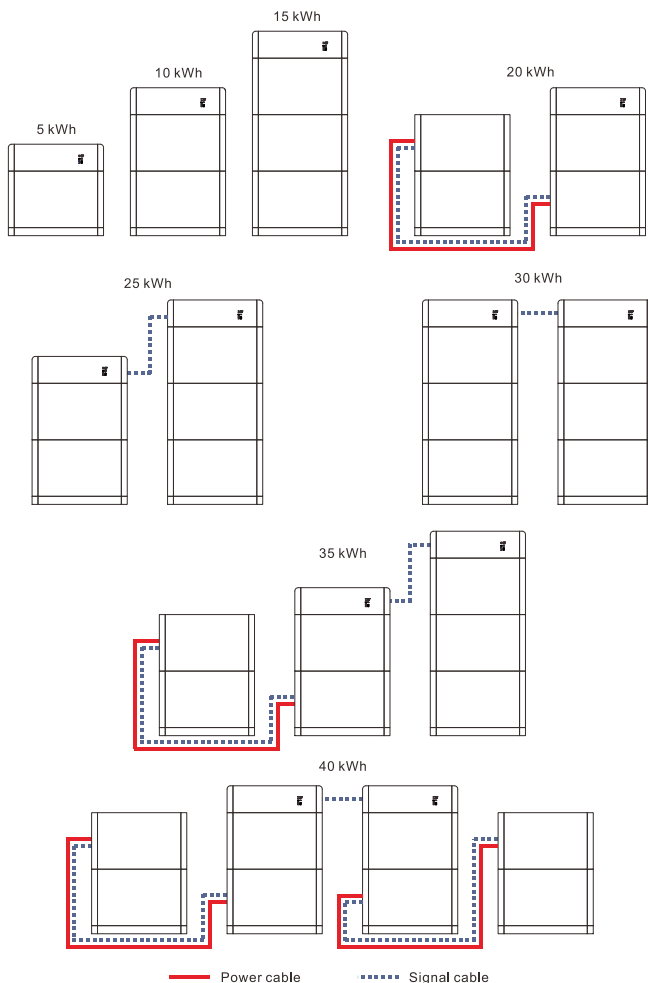





Figure. 2-8 Schematic diagram of system capacity expansion

# 3. Product Installation

## Announcements

|   |  |
|---|--|
| <br><b>Danger</b>    | <p>Do not install batteries on flammable materials.<br/>Do not install batteries in places where flammable or explosive materials are stored.</p>  |
| <br><b>Careful</b>   | <p>The enclosures and fins are very hot when battery modules is operated, so do not install battery systems where you may inadvertently come into contact with them.</p>                       |
| <br><b>Attention</b> | <p>Consider the weight of the battery module when transporting and moving it. Select suitable mounting position and surface. At least two persons are required to install battery modules.</p> |

### 3. 1. Checking Before Installation

#### Checking Outer Packing Materials

Packing materials and parts can be damaged in transit. Therefore, check the packing materials of battery modules and BDU before installing them. Check whether the outer packing materials are damaged, such as holes and cracks. If any damage is found, please do not open the package and contact the distributor as soon as possible. It is recommended that you remove packing materials within 24 hours before installation.

#### Checking packing list

After the battery modules and BDU are unpacked, check whether the packaging and accessories are intact. If any damage is found or any components are missing, contact the distributor.

Table 3-1 Components and mechanical parts to be delivered for battery modules











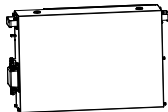
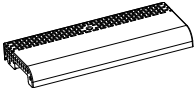
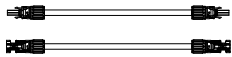
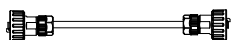







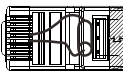
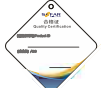
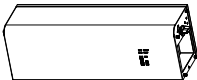

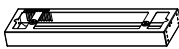

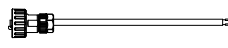



| No | Pictures  | Description                 | Quantity |
|----|---|-----------------------------|----------|
| 1  |    | Battery module              | 1pcs     |
| 2  |    | Protective cover            | 2pcs     |
| 3  |    | Battery power cable         | 2pcs     |
| 4  |    | Battery communication cable | 1pcs     |
| 5  |    | Anti-tip bracket A          | 2pcs     |
| 6  |    | Side connector              | 2pcs     |
| 7  |    | Anti-tip bracket B          | 2pcs     |
| 8  |    | Ground Cable                | 1pcs     |
| 9  |  | Hexagon screw M6*14         | 4pcs     |
| 10 |  | SEM screws M4*10            | 10pcs    |
| 11 |  | Expansion bolt M6*60        | 2pcs     |
| 12 |  | Terminal resistance         | 1pcs     |
| 13 |  | Quality Certificate         | 1pcs     |

Table 3-2 Components and mechanical parts to be delivered for BDU



| No | Pictures  | Description   | Quantity |
|----|---|---|----------|
| 1  |    | Battery distribution unit                               | 1pcs     |
| 2  |    | Left protective cover                                   | 1pcs     |
| 3  |    | Right protective cover                                  | 1pcs     |
| 4  |    | Base  | 1pcs     |
| 5  |    | base protective cover                                   | 2pcs     |
| 6  |    | BDU parallel communication cable                        | 1pcs     |
| 7  |    | BMS communication cable                                 | 1pcs     |
| 8  |   | Hexagon screw M6*14                                     | 4pcs     |
| 9  |  | SEM screw M4*10   | 10pcs    |
| 10 |  | Expansion bolt M6*60                                    | 4pcs     |
| 11 |  | Battery positive terminal + input terminal plastic case | 1pcs     |
| 12 |  | Battery negative terminal - input terminal plastic case | 1pcs     |







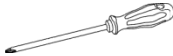

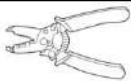

|    |   |  |      |
|----|---|--|------|
| 13 |  | Battery positive + input terminal metal core | 1pcs |
| 14 |  | Battery negative - Input terminal metal core | 1pcs |
| 15 |  | Anti-tip bracket A                           | 2pcs |
| 16 |  | Side connector                               | 2pcs |
| 17 |  | Anti-tip bracket B                           | 2pcs |
| 18 |  | Manual                                       | 1pcs |
| 19 |  | The warranty card                            | 1pcs |
| 20 |  | Quality Certificate                          | 1pcs |

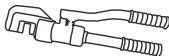
### 3. 2. Preparation for Installation Tools

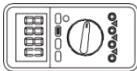
Prepare tools for installation and electrical connections.

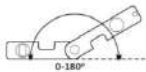
Table 3-3 Tools required for installation and electrical connections

| NO | Tool  | Model  | Function   |
|----|---|--|--|
| 1  |  | Hammer drill<br>Recommend<br>Drill @ $\Phi 8\text{mm}$ | Used to drill holes on the wall.                     |
| 2  |  | 4mm<br>Screwdriver                                     | Remove and install screws and wires                  |
| 3  |  | Removal Tool   | Remove the output terminal of the battery module and |

|    |   |                |  |
|----|---|----------------|--|
|    |   |                | BDU  |
| 4  |    | Wire stripper  | Used to peel cable   |
| 5  |    | Sleeve         | Install Fixed support rack   |
| 6  |    | Crimping tools | Used to crimp OT connector   |
| 7  |    | Heat gun       | Used to coated with heat shrinkable casing   |
| 8  |    | Multi meter    | Check whether the cable connection is correct, the positive and negative terminals of the battery are correct, and the grounding is reliable |
| 9  |    | Marker         | Mark signs   |
| 10 |   | Measuring tape | Measure distance   |
| 11 |  | Level          | Ensure the rear panel is properly installed  |
| 12 |  | ESD gloves     | Installer wear when installing product   |
| 13 |  | Safety goggle  | Installer wear when drill holes  |
| 14 |  | Mask           | Installer wear when drill holes  |

### 3. 3. Installation environment

Before installation, determine the proper position for installing the BTS series intelligent battery system.

The following requirements must be met:

- Choose a dry, clean, neat and convenient location for installation.
- Machine ambient temperature:  $-10^{\circ}\text{C}\sim 45^{\circ}\text{C}$ ;
- Relative humidity: 5-95% (non-condensing);
- The product should be placed in a well-ventilated place;
- There are no inflammable and explosive objects near the installation position of the product;
- The highest altitude of the installation environment is 4000m.

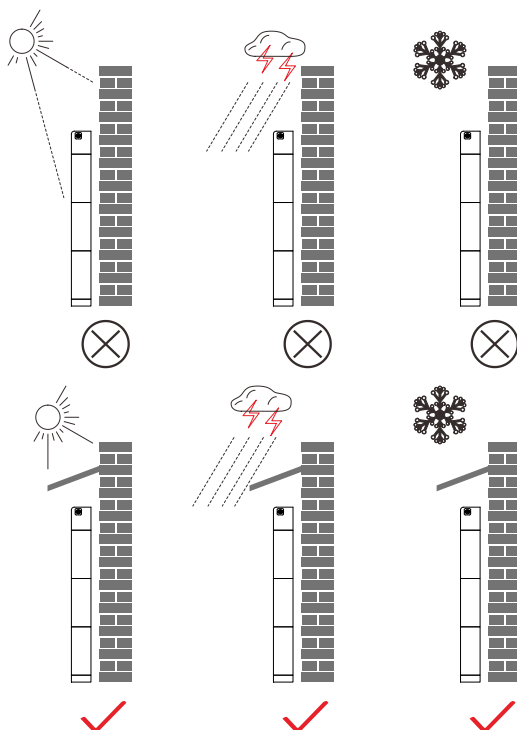

Figure. 3-1 Installation Environment Diagram

### 3. 4. Installation Space

To ensure sufficient space for installation and heat dissipation, reserve enough space around the BTS series battery system. The requirements are as follows:

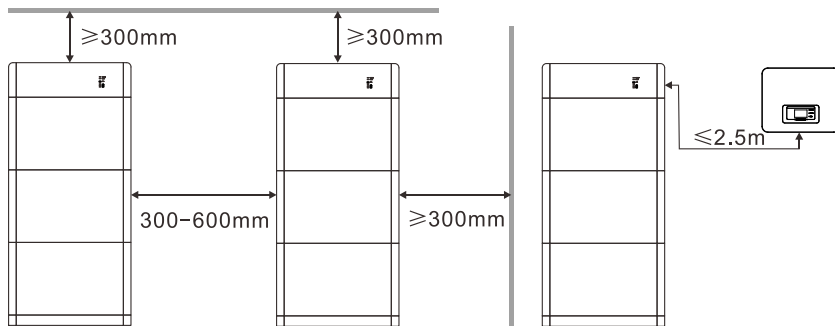

Figure. 3-2 Installation space diagram

### 3. 5. Battery system installation

### Installation dimensions diagram :

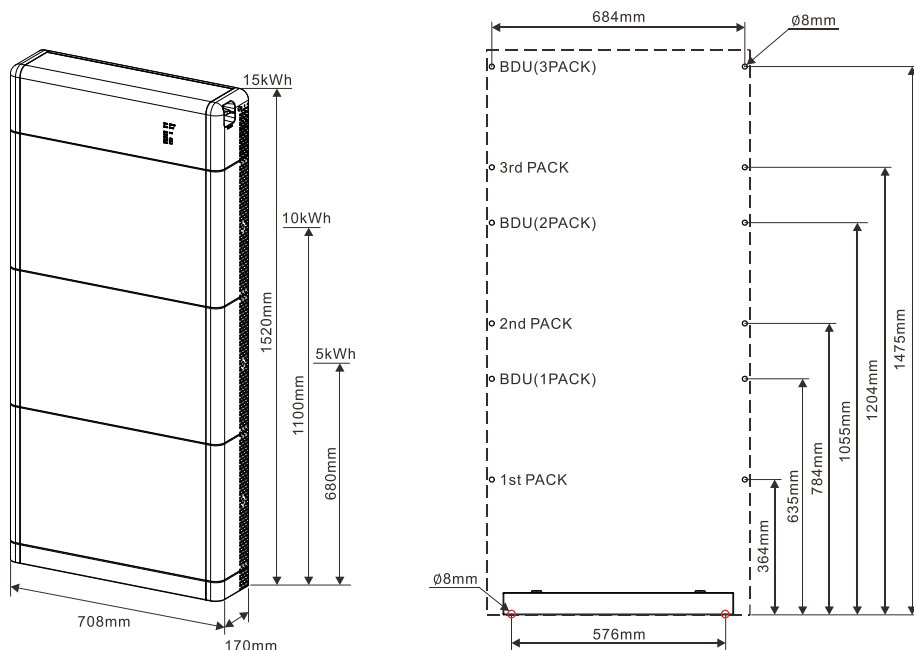

Figure. 3-3 System installation dimensions diagram

### Base installation

#### Procedure :

1) Place the base against the wall and keep it 10 to 25 mm away from the wall surface. Use a level to adjust the hole position and mark the hole position with a marker.

2) Remove the base, drill holes using a hammer drill ( $\phi$  8mm, depth range 60-65 mm), and tighten expansion bolt to ensure that the base is securely installed.

3) Mark the holes for fixing the battery module and BDU with a marker according to the dimensions shown in Figure 3-3.

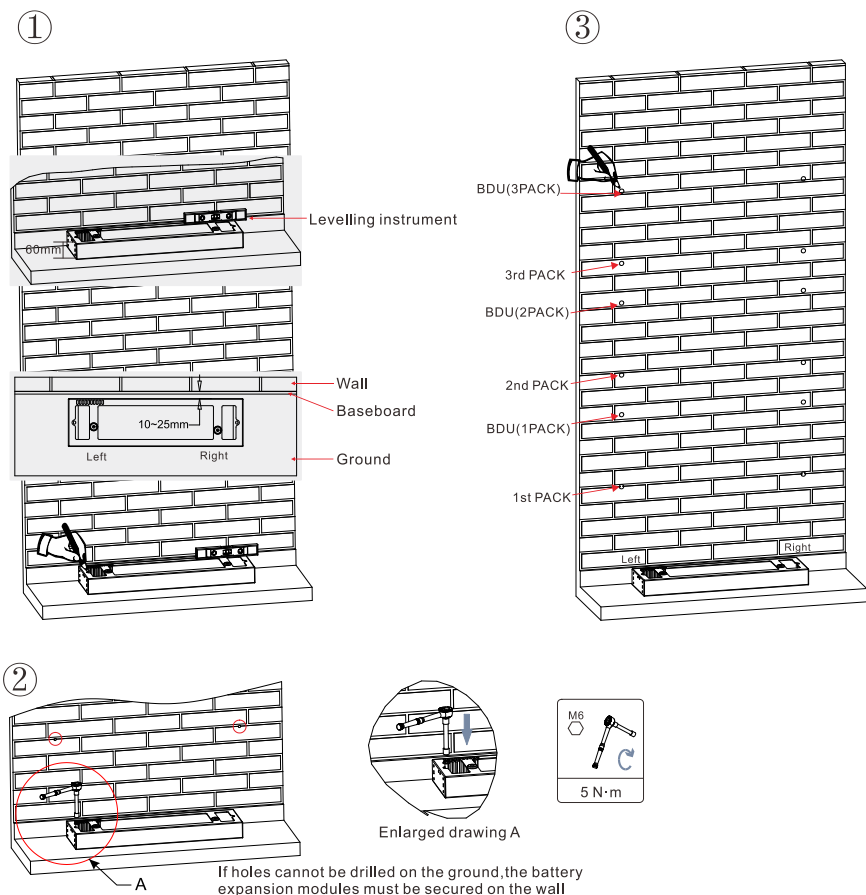

Figure. 3-4 base installation diagram

### Fixed installation between modules :

Procedure :

- 1) Place the first battery module on the base.
- 2) Install connectors on both sides and tighten the six screws with a cross screwdriver.
- 3) Install the remaining battery modules and BDU from bottom to top. (Before installing the next module, ensure that the screws on the side connectors of the previous module are firmly installed.)

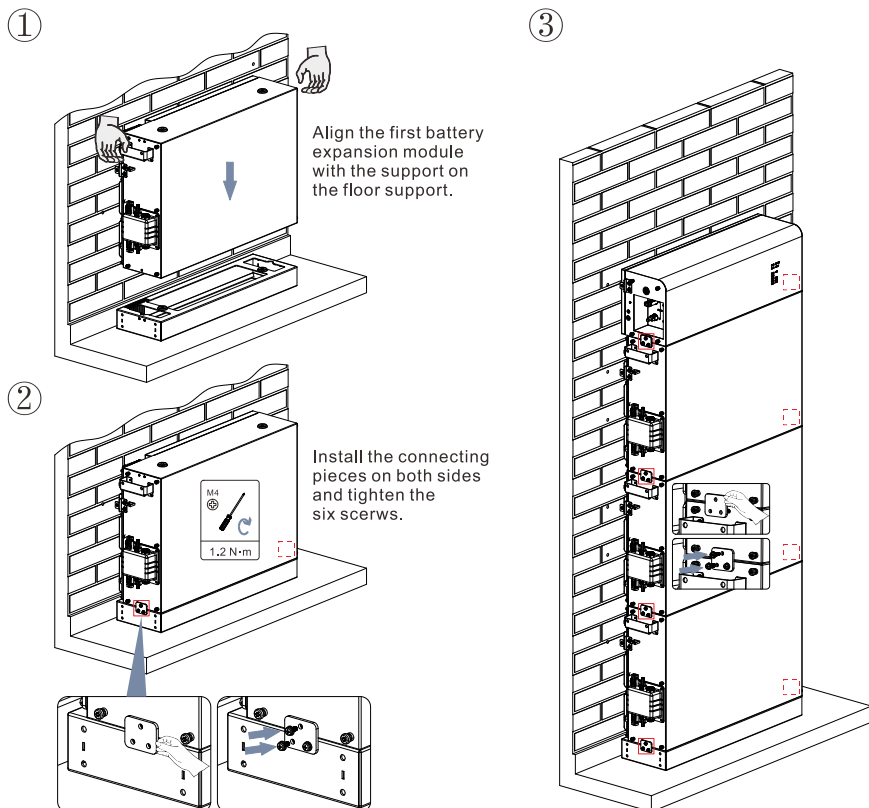

Figure. 3-5 Battery module installation diagram

### Anti-tip bracket installation:

Procedure:

- 1) Drill holes with a hammer drill ( $\varnothing$  8mm, depth range 60-65 mm). Reposition and drill the holes, if the original one has a large deviation.
- 2) Install the anti-tip bracket B on the wall, and fasten expansion bolt.
- 3) Adjust the anti-tip bracket A, make sure the holes are matched between anti-tip bracket A and anti-tip bracket B.
- 4) Connect and fix the anti-tip bracket A and anti-tip bracket B with M6\*16 screws.

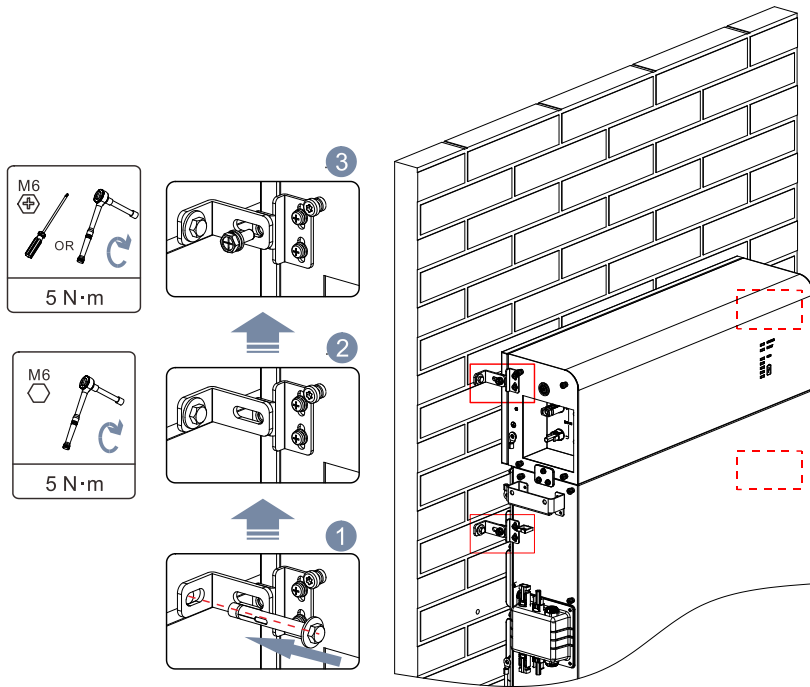





Figure. 3-6 Schematic diagram of wall fixing installation

## 4. Electrical Connection

This product is used for battery energy storage PV system. Equipment can be damaged if not used as intended.

|   |   |
|---|---|
|  | <p>Only professional electrical engineers can install and maintain batteries.</p>   |
| <p>Attention</p>  | <p>When making electrical connections, wear rubber gloves and protective clothing.</p> <p>When connecting the device electrically, you must first connect the protection ground cable. When removing a device, ensure that the PGND cable is removed at last.</p> |
|  | <p>Before electrical connection, ensure that the DC switch of the BDU is OFF, the black start switch indicator is OFF, and the battery module has no output voltage.</p>  |
| <p>Danger</p>   | <p>Prepare a battery cable and ensure that the positive and negative output polarities of the battery are correct; otherwise, the device may be damaged.</p>  |
|  | <p>The equipment damage caused by operator's wrong wiring is not covered by the product warranty.</p>   |
| <p>Note</p>   |   |

## 4. 1. Preparation of Connection Cables

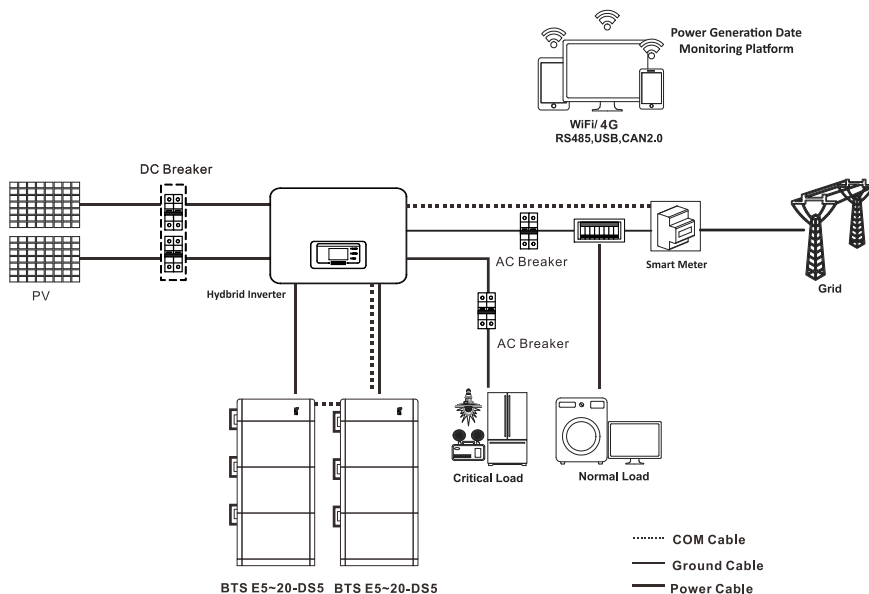

Figure 4-1 System connection diagram

Table 4-1 Cables prepared by customers

| No | Cable                                   | Recommended specifications |
|----|---|----------------------------|
| 1  | Power cable connect the BDU to inverter | UL10269 10AWG              |
| 2  | Grounding cable                         | UL10269 8AWG               |

## 4. 2. Electrical Connection for Internal System

### 4.2.1 Protection grounding cable connection

Procedure:

As shown in Figure 4-2, connect the grounding points between modules with protective grounding cables and ensure reliable connection of grounding cables.

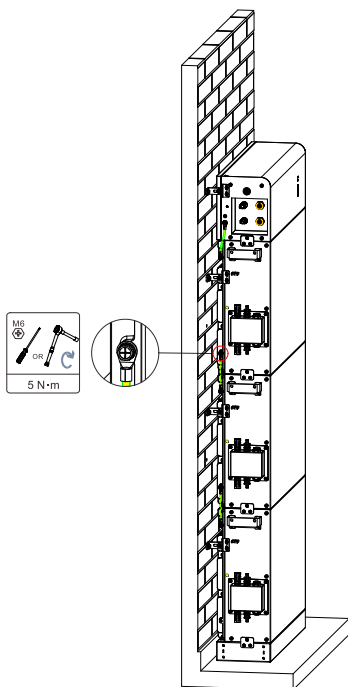

Figure. 4-2 Grounding cable connection diagram

## 4.2.2 Power cables connection

As shown in Figure 4-3, connect the BAT-IN power port on the BDU to the positive and negative terminals (B+ and B-) of the battery module using power cables. Connect the remaining battery modules from top to bottom in this way, and secure the cables using cable ties. Ensure that the cables are securely

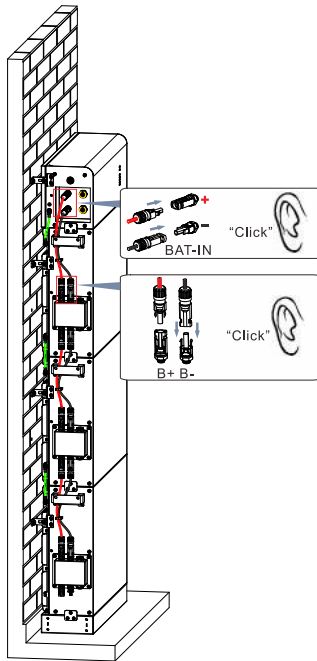

Figure. 4-3 Diagram of internal power cable connection

### 4.2.3 Communication cable connection

Procedure:

- 1) Connect the Link Port on the BDU to the Link Port In Port on the battery module by using a communications cable, lock the nut clockwise to ensure reliable connections, and connect the remaining battery modules from top to bottom, and secure them with cable ties.
- 2) Install a terminal resistor on the Link Port Out Port of the last battery module in the system, and lock the nut clockwise to ensure a firm and reliable connection (missing the terminal resistor may cause battery communication failure).

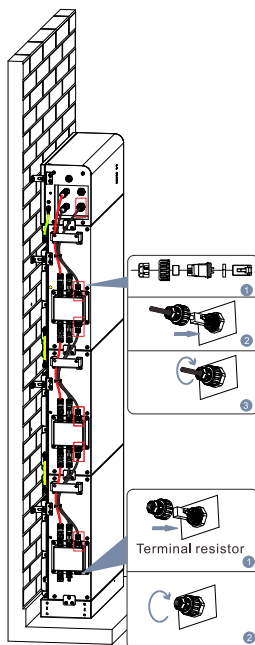

Figure. 4-4 Diagram of internal signal cable connection

**Note:**

For the safety of the battery system with a single cluster capacity of 20kWh, a base installation package is recommended and divided into two columns for installation. The following points should be paid attention to during electrical connection:

- 1) Connect the power cable. Connect the upper expansion terminal (B+,B-) on the uppermost battery module in one column (without the DBU) to the lower expansion terminal (B+,B-) on the bottom battery module in the other column.
- 2) For communications cable connections, connect the Link Port In on the uppermost battery module in one column (without the BDU) to the Link Port Out on the bottom battery module in the other column.

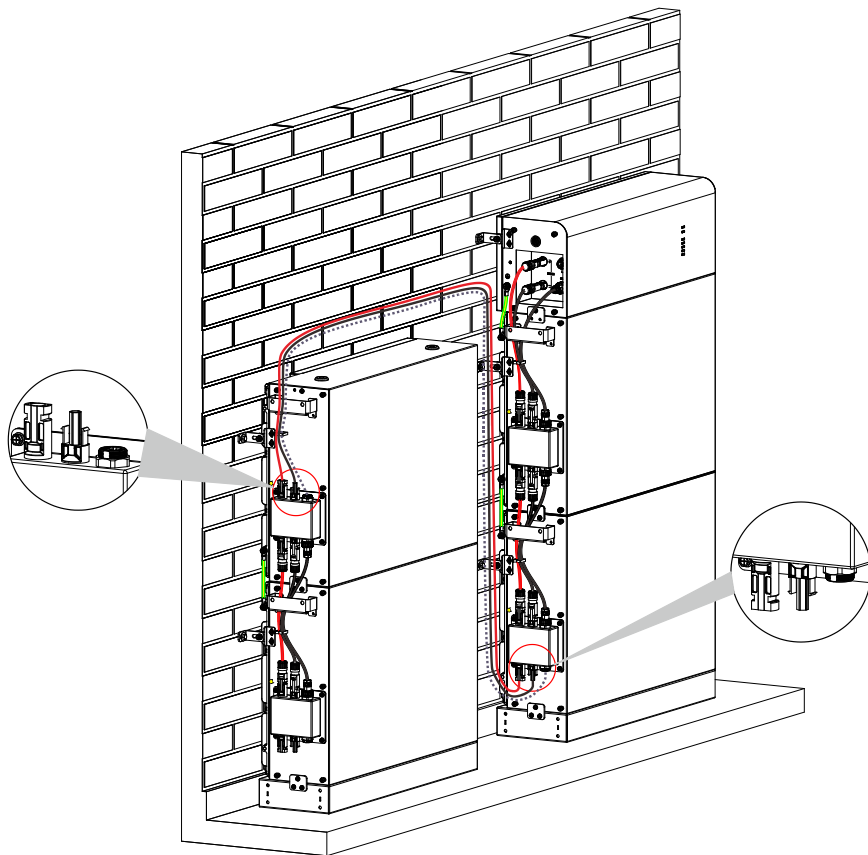

Figure. 4-5 Battery cluster installation diagram for 20kWh

## 4. 3. External Electrical Connection

### 4.3.1 External Electrical Connection

The following is an example of the SOFARSOLAR storage inverter HYD 5~ 20kTL-3PH:

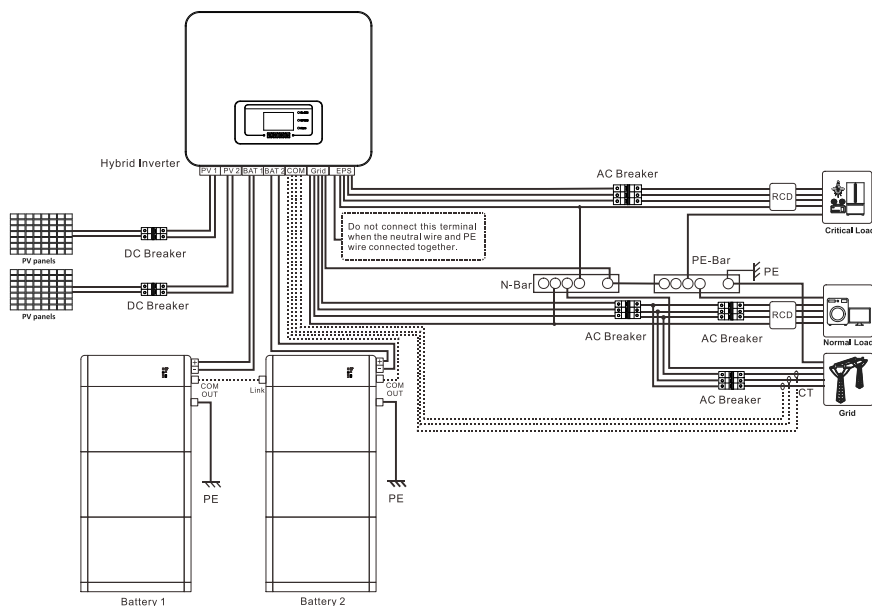

Figure. 4-6 System Connection Diagram (Australia)

This is the schematic diagram of the application system where neutral line and ground line are connected together. For example, in Australia, New Zealand, South Africa and other countries, please follow the local safety requirements of the power grid.

Note: According to Australian safety regulations, the neutral cables on the grid-connected side and EPS side must be connected together, otherwise the EPS function will not work.

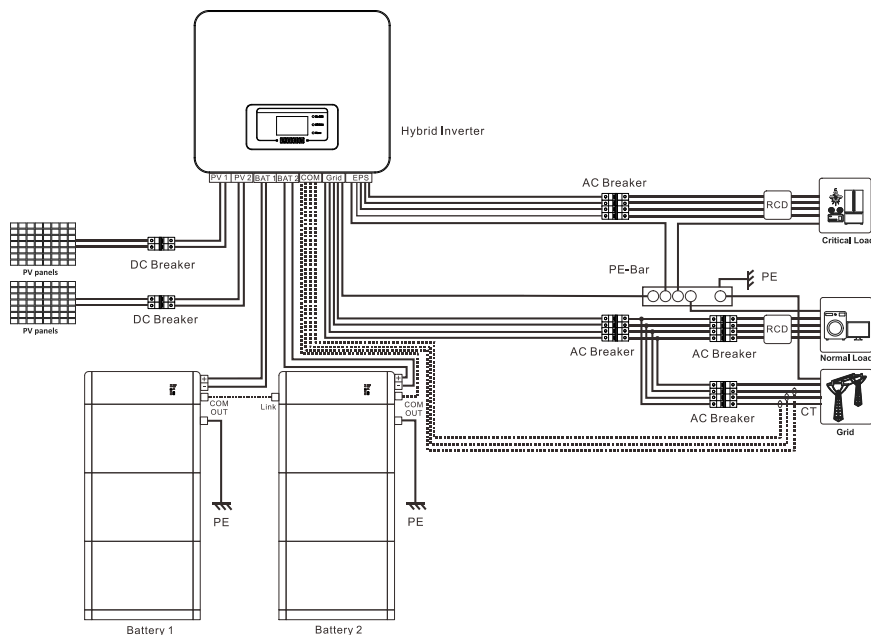



Figure. 4-7 System Connection Diagram

### 4.3.2 External ground Connection of the PGND cable

#### Step1: Crimp OT terminals

|   |  |
|---|--|
|  | <p>When stripping the cable, do not scratch the core of the cable.</p>   |
| <p><b>Attention</b></p>   | <p>The grounding cable must be prepared by yourself. the grounding cable must be 8AWG and meet the requirements for outdoor use.</p> <p>The cavity formed after the conductor crimping plate of the OT terminal is fully covered with the cable core, and the cable core is tightly bound to the OT terminal. The pull-out force after the crimping complies with UL486A and UL310</p> |

standards.

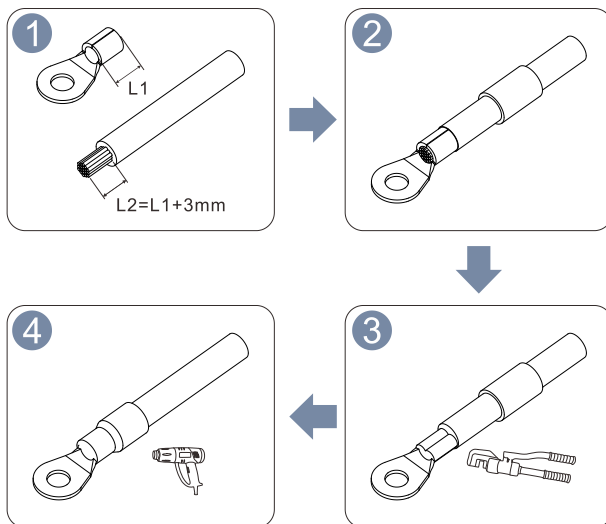

Figure. 4-8 Diagram of Crimping OT terminals

Step 2: As shown in Figure 4-8, install a protection ground cable at the ground terminal on the right of the BDU and connect it to the external ground protection point.

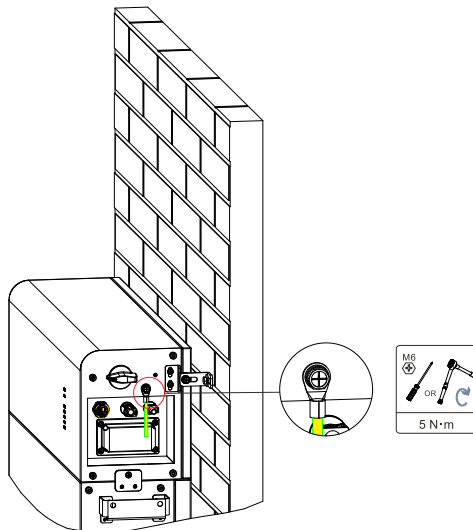

Figure. 4-9 Installation diagram of the protection ground cable

### 4.3.3 DC power cable installation

Procedure:

- 1) Select proper cable types and specifications based on Table 4-1. Remove cable connectors from positive and negative connectors. (It is suggested to use different colors to distinguish positive and negative poles).
- 2) Use a wire stripper to strip off the insulation layer of the positive and negative cables to a proper length. For details, see the peeling length diagram.4-10.
- 3) Insert the positive and negative cables with the insulation layer removed into the positive and negative metal terminals, and use crimping pliers to press the cable to the metal core of the terminal. Ensure that the cable is firmly crimped with the metal core.
- 4) The crimped positive and negative cables pass through the

locking nut and are inserted into the corresponding plastic shell respectively until a clicking sound is heard, indicating that the metal core is clamped into place. Tighten the locking nut.

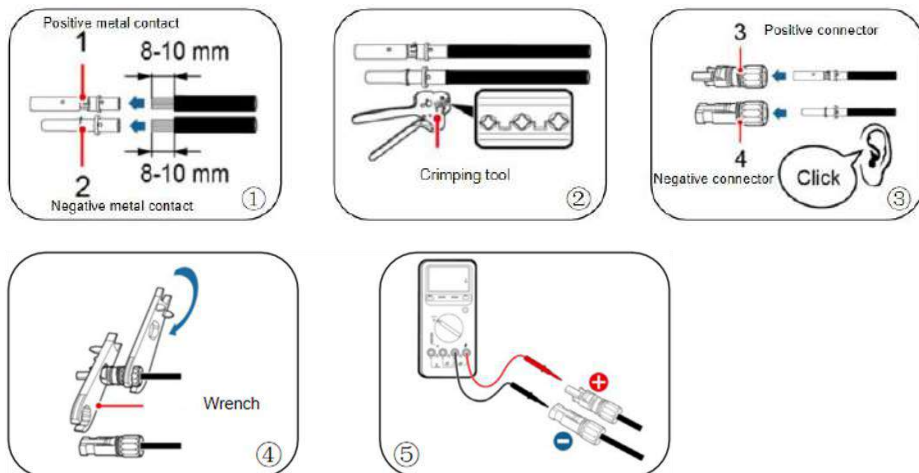

Figure. 4-10 Assembly diagram of battery DC terminal connector

To remove the BAT positive and negative connectors from the battery module or battery power distribution unit, insert the BAT positive and negative connectors into the bayonet as shown in figure 4-11 and press them down to remove the DC connectors, as shown in Figure 4-11.

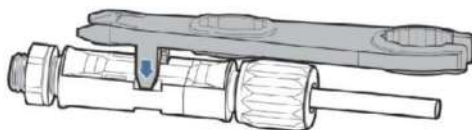

Figure. 4-11 Disconnect PV connectors

- 5) Use a multi meter to check the positive and negative poles ,Connect the assembled DC terminal connector to the DC B+/B- input terminal on the battery power distribution unit, and connect the other end to the inverter side. Ensure that the connection is secure.

### Notice during installation:

- It is not recommended to use armored cables for dc input cables to avoid cable breakage.
- Before assembling the DC connector, ensure that the polarity of the cable is correct and label the positive and negative cables
- After crimping the positive and negative metal terminals, pull back the DC input cable to ensure that the cable connection is secure.
- If the capacity of a cluster is higher than 15kWh, the batteries should be installed and connected in two columns.

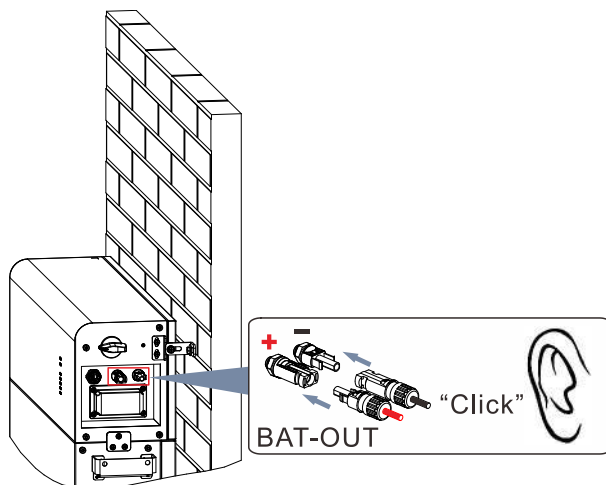

Figure. 4-12 Battery power cable Installation diagram

### 4.3.4 BMS communication cable installation

Install the communication cable delivered with the accessories to the COM-OUT port of the battery distribution box, and connect the other end to the BMS communication ports CAN-H and CAN-L of the inverter respectively according to the label definition.

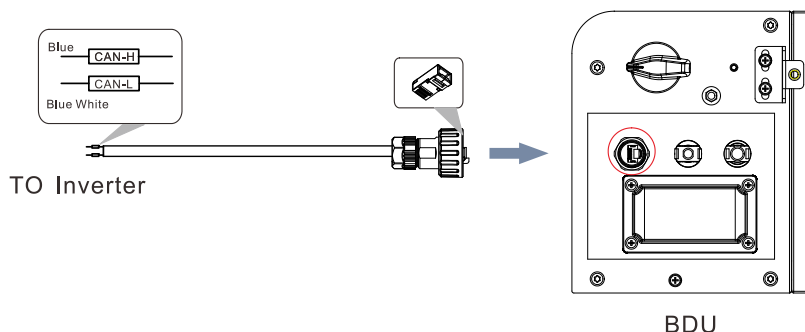

Figure. 4-13 BMS diagram of communication connection cable installation

The COM-OUT port pins of the battery distribution unit(BDU) are defined as follows :

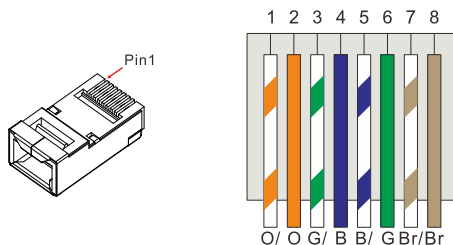

Figure. 4-14 COM-OUT port pin definition for battery distribution box

Table 4-2 Communication cable pin definition

| Pin  | Wire color   | Definition |
|------|--------------|------------|
| PIN1 | Orange White |            |
| PIN2 | Orange       |            |
| PIN3 | Green White  |            |
| PIN4 | Blue         | CAN-H      |
| PIN5 | Blue White   | CAN-L      |
| PIN6 | Green        |            |
| PIN7 | Brown White  |            |
| PIN8 | Brown        |            |

## 4. 4. Battery parallel installation

The BTS series battery supports expansion up to two battery clusters. Power cables are connected to the inverter through the BDU, as shown in Figure 4-15. The battery cluster connected to the inverter is a slave, and the other cluster is a master. The parallel communication cable is connected from the COM-OUT port of the master to the Link port of the slaver. Install a terminal resistor on the last battery module of the master.

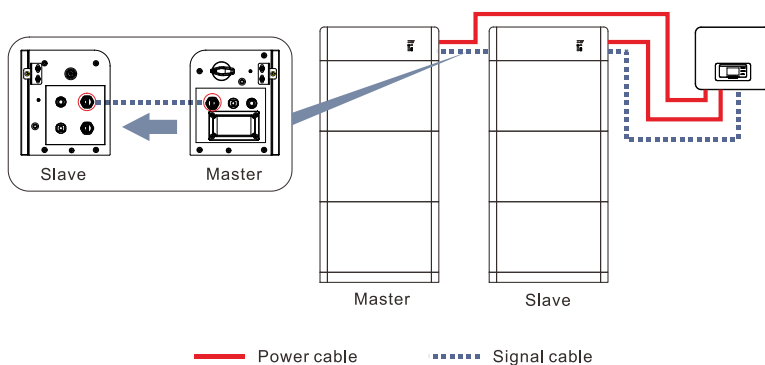

Figure. 4-15 Diagram of battery parallel installation

## 4. 5. Fuse replacement

If the fuse of the battery distribution unit is damaged, replace it by a professional engineer

Procedure:

- 1) To power OFF the battery system, set the switch of the battery distribution unit to OFF, turn OFF the indicator of the battery black start switch, and all the LED indicator of the battery distribution unit is OFF. To power OFF the system for five minutes, ensure that the remaining battery charges are discharged.
- 2) Use a cross screwdriver to loosen the screws on the fuses cover and remove the fuses cover.

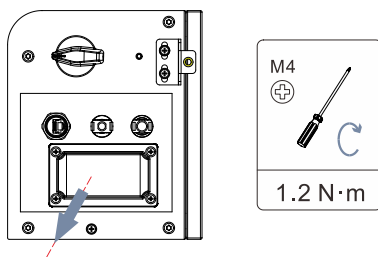

Figure. 4-16 Diagram of removing fuse outer cover

- 3) Open the fuse box backward, take out the damaged fuse, place a new fuse in the fuse slot, and close the fuse box until you hear a clicking sound, indicating that the fuse box is installed in place.

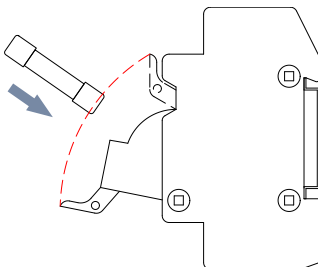

Figure. 4-17 diagram of replacing fuse

Table 4-3 Fuse model

| No | Brand   | Mode            | Specification Requirements  |
|----|---------|-----------------|---|
| 1  | SINO    | RS309-MF-14C40A | Rated Voltage: 750Vdc<br>Rated Current: 40A<br>Package Dimensions : 51*14.3mm |
| 2  | BUSSMAN | FWP-40A14Fa     |   |
| 3  | FRZ     | FRB-C14-63A     |   |

## 4. 6. Install the protective cover

After electrical connections are complete and cable connections are correct and reliable, install the external protective cover.

Procedure:

- 1) install protective covers on both sides of the base.
- 2) Install protective covers on both sides of the battery module or BDU.
- 3) Tighten the protective cover with screws.

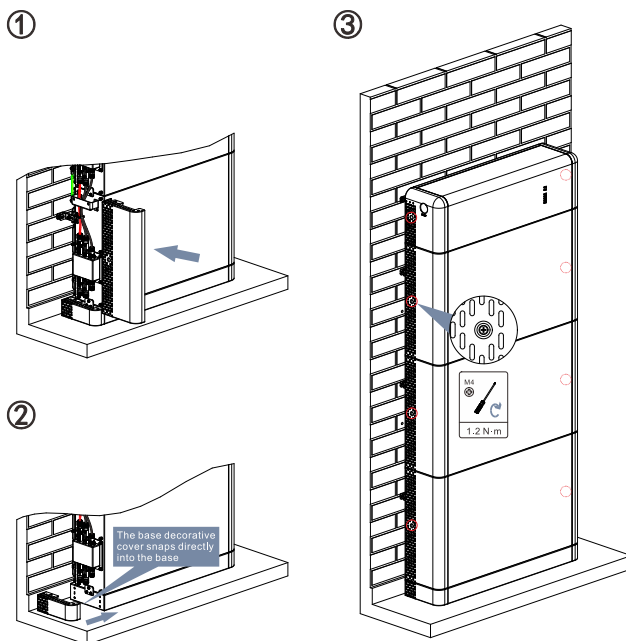

Figure. 4-18 Diagram of installing protective cover

## 5. Commissioning

### 5.1. Double Check

Please double check the following items before running:

- Battery module, BDU and the base should be completely fixed.
- Each BAT+/BAT- line is firmly connected, the polarity is correct, and the voltage is in line with the accessible range.
- The DC switch of the BDU is OFF, and the black start indicator is OFF.
- Ensure that the communication cable is firmly connected to the terminal resistor.
- Install sealing plugs on unused terminals or interfaces.
- Cable is arranged reasonably, and the cable is tidy and without damage.

### 5.2. Electrify for the First Time (Important)

- 1) Set the DC switch of the BDU to ON.
- 2) Press the black start switch on the BDU to power on the battery for the first time. Observe the LED indicator on the BDU to check the running status.

### 5.3. Battery Parameter Settings

If the system uses SOFARSOLAR HYD series inverter, the battery parameters can be set as follows::

Procedure:

#### **Battery Parameter Settings**

1) Battery type settings:

|                |                |            |                   |          |   |           |
|----------------|----------------|------------|-------------------|----------|---|-----------|
| Advanced setup | Enter password | Enter 0715 | Battery parameter | Battery1 | 1. Battery type                         | 7.BT S 5K |
|                |                |            |                   | Battery2 | 2. Discharge Depth                      |           |
|                |                |            |                   |          | 3. Set the mandatory full - charge time |           |

2) Set discharge depth: Set the following parameters as required:

① Discharge depth : ② EPS discharge depth : ③ EPS restore the discharge

3) Set the mandatory full - charge time (The time difference is no less than 3 hours)

4) Save

Note: If batteries are connected to both battery channels of the inverter, perform the preceding steps to set battery parameters for batteries 1 and 2.

**Configures an address automatically**

After battery parameters are set, ensure that the system has reliable PV or utility power supply.

|                |                |            |                   |                                    |                                     |         |
|----------------|----------------|------------|-------------------|------------------------------------|-------------------------------------|---------|
| Advanced setup | Enter password | Enter 0715 | Battery parameter | Configure an address automatically | Configure an address automatically: | Confirm |
|----------------|----------------|------------|-------------------|------------------------------------|-------------------------------------|---------|

Note:

- The online batteries quantity is displayed on the auto IP address configuration page. You can configure the IP address automatically only after comparing the connected batteries

quantity with the actual quantity.

- The automatic configuration takes about 2 to 3 minutes.
- During the automatic address configuration, the corresponding PCU output is enabled or disabled. If the batteries quantity is incorrect, check the communications cable connection.

## 5. 4. Software Update

The product can be upgraded through the software of SOFARSOLAR HYD series energy storage inverters to maximize the performance of the product and avoid the abnormal operation of the product caused by software bugs.

Before upgrading the software, check that the communication cables of the system and the DC power cables of the battery are properly connected, and ensure that the system has reliable power supply from utility or PV during the upgrade.

Procedure:

- 1) Insert the USB drive into the computer.
- 2) The upgrade file folder is named firmware. After receiving the upgrade file, decompress it and save it in a USB disk.
- 3) Insert the USB disk into the USB/Wifi interface of the energy storage inverter .
- 4) Set the DC switch of the battery distribution unit to "ON state", press the black start switch, and the energy storage inverter and battery start up and run.
- 5) Perform the following operations on the LCD of SOFARSOLAR HYD series energy storage inverter:

|                   |                |            |                |                |
|-------------------|----------------|------------|----------------|----------------|
| 6.Software Update | Enter Password | Enter 0715 | 1.PCS Updating | Start Updating |
|                   |                |            | 2.BMS Update   | Updating BMS   |
|                   |                |            | 3.PCU Update   | Updating PCU   |
|                   |                |            | 4.BDU Update   | Updating BDU   |

6) If the following error occurs, upgrade again. If this situation persists for several times, contact technical support for help.

|                    |                    |                    |                    |
|--------------------|--------------------|--------------------|--------------------|
| USB error          | BDU file error     | PCU file error     | BMS file error     |
| ARM file error     | Upgrading BDU fail | Upgrading PCU fail | Upgrading BMS fail |
| Upgrading ARM fail |                    |                    |                    |

7) After the upgrade is complete,you can view the current software version in System Info >> Software Version.

### 5. 5. Battery Powered Off

- 1) Press the black start switch of BDU.
- 2) Set the DC switch of the BDU to OFF. All the LED indicators on the battery distribution box are OFF. After the system is powered OFF for five minutes, ensure that the remaining battery charges are discharged before performing maintenance.

# 6. Trouble shooting and main tenance

## 6. 1. Troubleshooting

This section describes the potential errors for this product. Please read carefully for the following tips when doing the troubleshooting:

- 1) For details about the warning or error information displayed on the BDU status indicator, see 2.4 Description of Battery Status Indicators.
- 2) When the battery generates an alarm or error message, the alarm report is uploaded to the inverter. You can determine the cause of battery alarms or faults by viewing the inverter display or the monitoring system.

If the SOFARSOLAR HYD series hybrid energy storage inverter is used, you can view the recorded fault information by following the following steps: Press "Back" on the home screen to enter the main menu, select "Event List" and press "OK" to enter.

Fault information list of SOFARSOLAR HYD series energy storage inverter:

Table 6-1 Fault information list of the energy storage inverter

| ID No. | Event Name                                | Solution   |
|--------|---|--|
| 157    | Lithium battery 1 communication is faulty | Check whether the communication cable or port of the battery module is faulty. |
| 158    | Lithium battery 2 communication is faulty |  |
| 159    | Lithium battery 3 communication is faulty |  |
| 160    | Lithium battery 4                         |  |

|     |                                    |  |
|-----|------------------------------------|--|
|     | communication is faulty            |  |
| 177 | BMS over voltage alarm             | The lithium battery is faulty. Shut down the inverter and lithium battery. Wait for 5 minutes and start the inverter and lithium battery. Check whether the fault is rectified. If not, contact technical support. |
| 178 | BMS under voltage alarm            |  |
| 179 | BMS high temperature alarm         |  |
| 180 | BMS low temperature alarm          |  |
| 181 | BMS over current alarm             |  |
| 182 | BMS short circuit alarm            |  |
| 183 | BMS version inconsistency          | Contact SOFARSOLAR technical support.  |
| 184 | BMSCAN version inconsistency       |  |
| 185 | BMS CAN version is too low         |  |
| 801 | The charging soft start failed     | Restart the battery. If the problem is not resolved, please contact SOFARSOLAR technical support .   |
| 802 | The discharging soft start failed  |  |
| 807 | PCU version inconsistency          |  |
| 808 | Radiator 1 high temperature alarm  | Power off and wait for 2 hours. If the problem is not solved, please contact SOFARSOLAR technical support.   |
| 809 | The ambient temperature overheats. |  |
| 813 | Charging prohibition alarm         | Restart the battery. If the problem is not resolved, please contact SOFARSOLAR technical support.  |
| 814 | Discharging prohibition alarm      |  |
| 815 | Battery imbalance alarm            |  |
| 928 | Battery reversal                   |  |
| 929 | Fusing failure                     |  |

3) If the battery status indicator does not indicate any error,

perform the following steps to check whether the current installation status meets the battery operating requirements:

- Is the battery installed in a clean, dry, well-ventilated location?
- Check whether the battery DC switch is off?
- Check whether the cable section and length meet requirements?
- Is the wiring good?
- Whether the configuration Settings are correct for the user's specific installation?
- Whether the communication cable is correctly connected and is not damaged?

## 6. 2. Daily Maintenance

|   |   |
|---|---|
|  | <p>After the battery is powered off for 5 minutes, ensure that the capacitor inside the battery is discharged before maintenance.</p> |
| <b>Attention</b>  |   |

Batteries usually do not require maintenance or calibration, but ensure that the radiator is not covered with dust, dirt, etc.

### 1) Clean the battery module

Please clean the battery module with an air blower, a dry & soft cloth or a soft bristle brush. Do not clean the inverter with water, corrosive chemicals, detergent, etc.

### 2) Clean the heat sink

In order to ensure the normal function and long service life of the product, it is necessary to ensure that there is enough air flow space around the radiator at the rear of the product, and there is no material around the radiator that obstructs the air flow, such as dust or snow, must be removed. Clean the heat sink with compressed air, a soft cloth, or a soft brush. Do not use water, corrosive chemicals, cleaning agents, or strong

detergents to clean the radiator.

### 6. 3. Battery Module Storage Requirements and Power Supply

Battery Module Storage Requirements:

- Environment temperature:  $-10^{\circ}\text{C}\sim 45^{\circ}\text{C}$ , Recommended storage temperature:  $25^{\circ}\text{C}\sim 35^{\circ}\text{C}$ .
- Storage relative humidity range: 5%~70%.
- Store in a dry, clean, and ventilated environment, away from direct sunlight.
- When storing the battery module, place it correctly. Do not put the battery module upside down or on its side.
- If the battery module is stored for a long time, replenish the power supply periodically. Battery module power supply requirements: the charging current is less than or equal to 7A, and the battery module needs to be charged to 50%SOC.

#### Recharge Requirements During Normal Storage

When the battery is stored for a long time, you need to perform regular maintenance. If the storage time is close to that shown in the following table, arrange supplementary power supply in time.

Recharge conditions when in storage

| Storage Environment Temperature              | Relative Humidity of Storage Environment | Storage Time     | SOC                              |
|--|--|------------------|----------------------------------|
| $< -10^{\circ}\text{C}$                      | /  | Prohibit         | /                                |
| $-10^{\circ}\text{C}\sim 25^{\circ}\text{C}$ | 5%~70%                                   | $\leq 12$ months | $30\% \leq \text{SOC} \leq 60\%$ |
| $25^{\circ}\text{C}\sim 35^{\circ}\text{C}$  | 5%~70%                                   | $\leq 6$ months  | $30\% \leq \text{SOC} \leq 60\%$ |
| $35^{\circ}\text{C}\sim 45^{\circ}\text{C}$  | 5%~70%                                   | $\leq 3$ months  | $30\% \leq \text{SOC} \leq 60\%$ |

|       |   |          |   |
|-------|---|----------|---|
| > 45℃ | / | Prohibit | / |
|-------|---|----------|---|

### Recharge Requirements When Over Discharged



Recharge the battery within the time range specified in the following table (90%DOD). Otherwise, the over discharged battery module will be damaged.

Recharge conditions when battery is over discharged

| Storage Environment<br>Temperature | Storage Time | Note        |
|------------------------------------|--------------|-------------|
| -10℃~25℃                           | ≤15 days     | /           |
| 25℃~45℃                            | ≤7 days      | 30%≤SOC≤60% |
| -10℃~45℃                           | ≤12 hours    | /           |

# 7. Technical Parameters

## Technical parameters

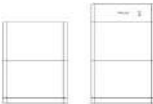
| System Parameters                 |   |   |   |  |
|-----------------------------------|---|---|---|--|
| Model                             | BTS E5-DS5  | BTS E10-DS5   | BTS E15-DS5   | BTS E20-DS5  |
| System schematic                  |  |  |  |  |
| Battery type                      | LFP   |   |   |  |
| Battery distribution unit         | BTS 5K-BDU  |   |   |  |
| Qty.of battery distribution unit  | 1   |   |   |  |
| Battery module                    | BTS 5K  |   |   |  |
| Qty.of battery modules            | 1   | 2   | 3   | 4  |
| Battery total energy[1]           | 5.12kWh   | 10.24kWh  | 15.36kWh  | 20.48kWh   |
| Usable Energy[2]                  | 4.75kWh   | 9.5kWh  | 14.25kWh  | 19kWh  |
| Rated power                       | 2.5kW   | 5kW   | 7.5kW   | 10kW   |
| Rated voltage                     | 400V  |   |   |  |
| Voltage range for full Load       | 350V~425V   |   |   |  |
| Rated charge/ discharge current   | 7A  | 14A   | 21A   | 28A  |
| Degree of protection              | IP65  |   |   |  |
| Ambient temperature range[3]      | -10℃~+50℃   |   |   |  |
| Allowable relative humidity range | 5~95%   |   |   |  |
| Max. operating altitude[4]        | 4000m   |   |   |  |

| Weight                            | 59kg                                      | 110kg              | 161kg              | 212kg                               |
|-----------------------------------|---|--------------------|--------------------|-------------------------------------|
| Dimension(W*D*H)                  | 708*170*680<br>mm                         | 708*170*1100<br>mm | 708*170*1520<br>mm | 708*170*900mm<br>708*170*1100<br>mm |
| Installation                      | Floor stand                               |                    |                    |                                     |
| Cooling                           | Natural                                   |                    |                    |                                     |
| Display                           | LED indicator                             |                    |                    |                                     |
| Communication                     | CAN                                       |                    |                    |                                     |
| Compatible inverters              | Refer to BTS E5~20-DS5 configuration list |                    |                    |                                     |
| <b>Battery Module</b>             |   |                    |                    |                                     |
| Model                             | BTS 5K                                    |                    |                    |                                     |
| Battery module energy[1]          | 5.12kWh                                   |                    |                    |                                     |
| Depth of discharge (DOD)          | 90.0%                                     |                    |                    |                                     |
| Rated power                       | 2500W                                     |                    |                    |                                     |
| Dimension(W*D*H)                  | 708*170*420mm                             |                    |                    |                                     |
| Weight                            | 50kg                                      |                    |                    |                                     |
| <b>Battery Distribution Unit</b>  |   |                    |                    |                                     |
| Model                             | BTS 5K-BDU                                |                    |                    |                                     |
| Max. charge/ discharge<br>current | 35A                                       |                    |                    |                                     |
| Dimension(W*D*H)                  | 708*170*200mm                             |                    |                    |                                     |
| Weight                            | 7.5kg                                     |                    |                    |                                     |
| <b>Standard</b>                   |   |                    |                    |                                     |
| Certificates                      | UN38.3, IEC62619, IEC62040-1, SAA etc.    |                    |                    |                                     |

[1]Test conditions:0.2C charge/discharge at 25℃,100%DOD.

[2]Usable Energy is based on battery cell only.

[3]Refer to the temperature derating curve.

[4]If the altitude is >2000m, derating operation is required, refer to the derating curve.

## ***8. Manufacturer's Warranty and Liability Terms***

### **Warranty period**

Warranty period and calculation method of SOFARSOLAR battery products refer to the Quality Assurance Agreement of SOFARSOLAR BTS Series Intelligent lithium battery System.

### **Extended warranty period**

If the purchased battery exceeds the warranty period stipulated in the Warranty Agreement of SOFARSOLAR BTS Series Intelligent lithium battery System, the customer can apply for the extended warranty period by providing the serial number of the product to the sales team of the company, and the Company has the right to reject the purchase application for the extended warranty period that does not meet the requirements.

If the original buyer wants to apply for the extended warranty service, please contact the sales team of Shenzhen SOFARSOLAR Co., LTD to purchase the products that exceed the extended warranty period but have not passed the warranty period stipulated in the Warranty Agreement of SOFARSOLAR BTS Series Intelligent lithium battery System, the original buyer shall bear different extended premiums.

Upon purchase of the extended warranty service, our company will issue an extended warranty card to the customer to confirm the extended warranty period.

### **Invalid warranty clause**

---

Equipment failure caused by the following reasons is not covered by the warranty:

- 1) The "warranty card" has not been sent to the distributor or Shenzhen SOFARSOLAR Co., LTD;
- 2) Without the consent of Shenzhen SOFARSOLAR Co., LTD to change equipment or replace parts;
- 3) Use unqualified materials to support Shenzhen SOFARSOLAR Co., LTD 's products, resulting in product failure;
- 4) Technicians who don't belong to SOFARSOLAR Co., LTD modify or attempt to repair and erase the product serial number or silk screen;
- 5) Incorrect installation, debugging and use methods;
- 6) Failure to comply with safety regulations (certification standards, etc.);
- 7) Damage caused by improper storage by dealers or end users;
- 8) Transportation damage (including scratches caused by internal packaging during transportation).Please claim directly from the transportation company or insurance company as soon as possible and obtain damage identification such as container/package unloading;
- 9) Failure to follow the product user manual, installation manual and maintenance guidelines;
- 10) Improper use or misuse of the device;
- 11) Poor ventilation of the device;
- 12) The product maintenance process does not follow relevant standards;
- 13) Failure or damage caused by natural disasters or other force (such as earthquake, lightning strike, fire, etc.)



## Intelligent Batteries System

---

Company Name: Shenzhen SOFARSOLAR Co., Ltd.

ADD: 11/F., Gaoxingqi Technology Building, No.67 Area, Xingdong Community, Xin'an Sub-district,  
Bao'an District, Shenzhen City,China

Email: [service@sofarsolar.com](mailto:service@sofarsolar.com)

Web: [www.sofarsolar.com](http://www.sofarsolar.com)